

Safety information ■ How the iStore works ■ Screen display & function guide ■ Troubleshooting ■ Warranty information



Congratulations on your purchase

Please keep this copy of your Owner's Manual as it contains important information about your solar hot water system.

iStore is a leading provider and installer of solar energy solutions. Our quality and design processes, combined with our years of experience in the solar industry has enabled us to develop a world class solar hot water storage product.



Important Information

- This manual includes all the necessary information regarding the installation and maintenance of this product. Please take the time to read it through before operating.
- The installer is to explain to the end user how to operate and maintain the unit in accordance to this instruction manual.
- iStore will not be held responsible for any damages or injuries caused by the incorrect installation of this hot water system.
- It is important that the installation and operational instructions laid out in this manual are strictly adhered to.
- A maintenance program must be carried out as recommended in this manual. Failure to comply with these recommendations will void the warranty.
- This manual could be subject to change without prior notice, if it is felt that product improvements are to be carried out.

iStore Basics

The iStore utilises an ingenious technology to efficiently transfer thermal energy directly from the surrounding air and into water, without dependence of the sun or fossil fuels to provide an energy source.



Characteristics

Smart and efficient unit

The operational costs can be up to 75% less than that of an electric water heater, and can be installed in locations which are unsuitable for solar hot water heating.

Safe and environmentally friendly

Produces no harmful gases along with no open flame, making the unit safe to work with when installing.

Easy to operate

Featuring an easy to use timer for both start and stop operations, with a controller to set the desired water temperature.

How Does The iStore Work?

1. A fan draws in air, containing heat energy, across the evaporator
2. The evaporator turns the liquid refrigerant into a gas
3. The compressor pressurises the refrigerant into a hot gas
4. The hot gas inside the condenser coil heats the water inside the coil-wrapped tank
5. The refrigerant reverts back to a liquid after heating the water and continues to the evaporator for the process to start again
6. The cycle continues until the set target temperature is achieved

As water is used in the home, the cycle will restart once the temperature in the lower section of the tank has dropped 11 degrees below the target temperature.

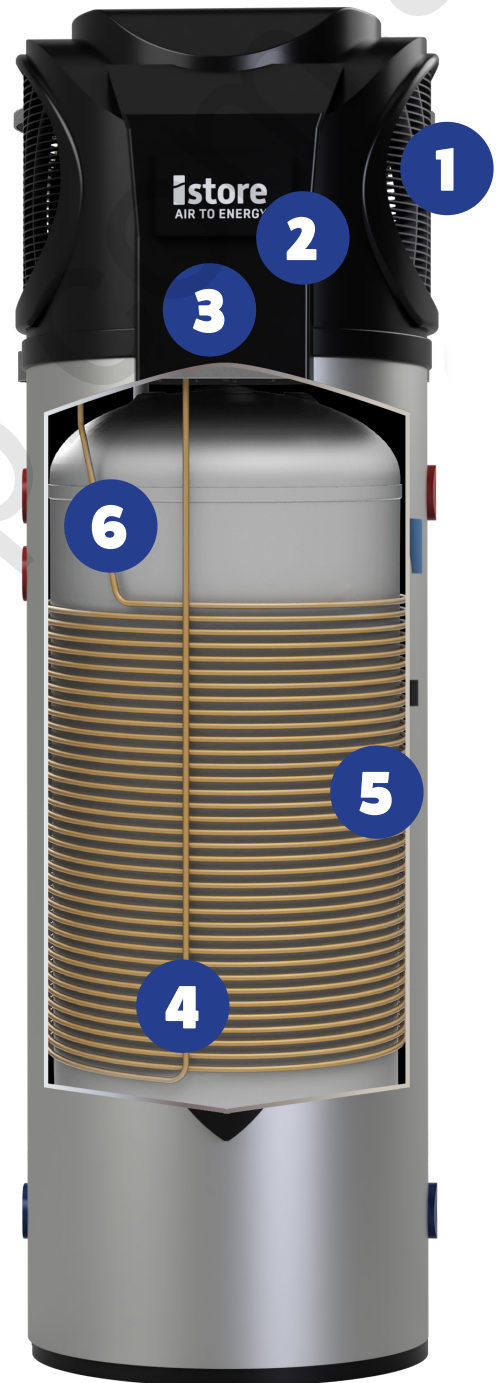

HOT WATER CAN CAUSE SERIOUS INJURY



WARNING - Hot water is dangerous! As a safety precaution, young children should always be supervised around hot water fixtures

THIS WATER HEATER IS ONLY INTENDED TO BE OPERATED BY PERSONS WHO HAVE THE EXPERIENCE OR THE KNOWLEDGE AND THE CAPABILITIES TO DO SO. THIS WATER HEATER IS NOT INTENDED TO BE OPERATED BY PERSONS WITH REDUCED PHYSICAL, SENSORY OR MENTAL CAPABILITIES I.E. THE INFIRM AND CHILDREN.

As solar water heaters can generate water temperature in excess of 50° C, regulations require that an approved solar rated tempering valve shall be installed in accordance with the valve manufacturer's instructions. This is required to prevent water temperatures supplied to the house exceeding a preset safe maximum. The tempering valve is connected to the hot water outlet lines. The valve must be fitted by an authorised plumber at the time of installation or in retrofitting to existing systems.

CHECK THE WATER TEMPERATURE BEFORE USE, SUCH AS WHEN ENTERING A SHOWER OR FILLING A BATH OR BASIN, TO ENSURE IT SUITABLE FOR THE APPLICATION AND WILL NOT CAUSE SCALD INJURY.

Hot water systems can store water at temperatures that can cause scalding. Water temperatures over 50°C can scald and care needs to be taken to ensure that injuries do not occur through incorrect use of your water heater.

If the water heater is left unused for two weeks or more, a small quantity of hydrogen gas (which is HIGHLY flammable) may accumulate in the top water cylinder. To dissipate this gas safely it is recommended that a sink or bath hot tap be turned on to dispel a couple of litres of water. During this procedure there should be no smoking, open flames or any electrical appliances such as washing machines or dish washers operating nearby. If Hydrogen is discharged through the tap, it will make a sound like air escaping.



GENERAL SAFETY INSTRUCTIONS

The installation of the iStore solar hot water systems requires the expertise of a licensed professional. The installation process must adhere to the guidelines set forth in the National Plumbing code (AS/NZS 3500.4), Australian Electrical Wiring Rules (AS/NZS 3000), as well as all applicable local plumbing and electrical regulations.

The electrically operated components of this water heater operate on 240v AC power.

The removal or attempted alteration of any electrical component must be conducted by a qualified electrical service person.

Care should be taken to avoid coming into contact with any pipe work or fixtures associated with the water heater.

For continued safety of this appliance, it must be installed, operated and maintained in accordance with the manufacturers instructions.

Intelligent Operating Modes

The Federal Government Clean Energy Regulator specifies how the iStore compressor hot water systems must operate in Australia and as such how the computer control operates. Intelligent and Hybrid modes are for overseas models and effectively overridden to Economic (ECO) mode in Australia.



Economic Heating Mode (ECO)

For Australian conditions ECO mode is the most appropriate, the onboard computer always monitors the surrounding temperature, incoming water and outgoing water, heat transfer capabilities and adjusts its operation to suit.



Vacation Mode

For use when away on holidays, enter the date of your return and the smart iStore will reduce usage to the government mandated weekly disinfect cycle only. Vacation mode reduces energy consumption while you are away.



Electric Element Heating Mode

The electric element will heat the water to the pre-set temperature and turn off once this is reached. The electric element heating mode is classified as a one-shot boost and will automatically turn off once the target temperature is reached.

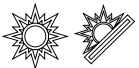

Intelligent Mode - (overseas models)



Hybrid Heating Mode - (overseas models)

Did you know?

The energy efficient iStore is fast becoming one of the most popular ways of heating your homes hot water. iStore's technology has been around for decades. The refrigeration industry has been utilising this incredibly efficient form of producing heating capacity ever since the first refrigerant gas was developed way back in 1928.

Functionality



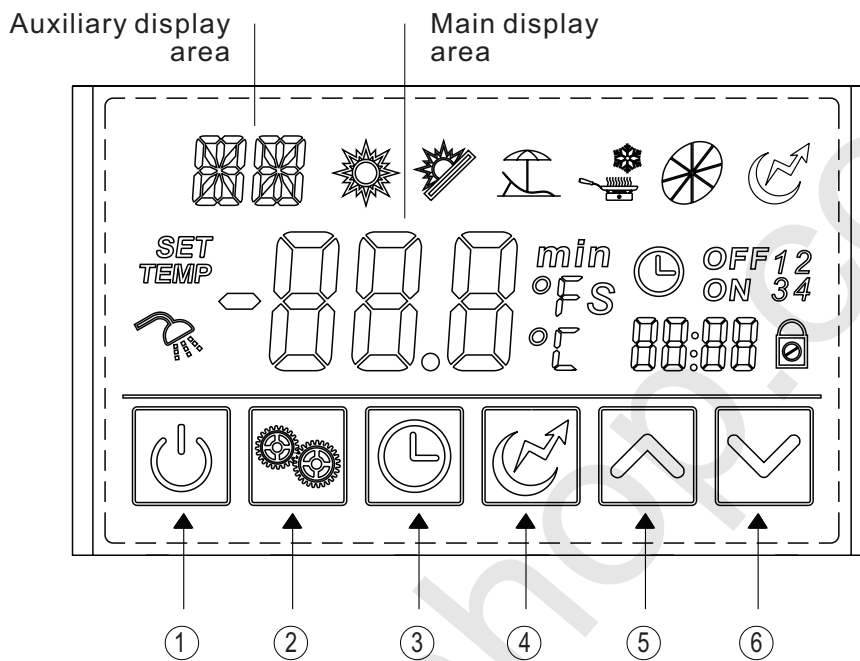





The function diagram of the LED display



Function of key

NO.	Button	Name	Function
①		ON/OFF	Turn on/off the unit.
②		Mode	Switch unit running modes or save setting parameters.
③		Clock	Set the clock or the timer.
④		Electric Heater	Turn on/off the electric heater or switch fan modes.
⑤		Up	Move up or increase parameter values.
⑥		Down	Move down or decrease parameter values.

Functionality

Status icon	Name	What it means
	Hybrid Heating	Shows that the unit is in hybrid heating mode.
	Eco Mode	Shows that the unit is in eco heating mode.
	Vacation	Shows that the unit is in vacation mode.
	Fan	Shows that the fan is on and the speed of the fan.
	Electric heater	Shows that the electric heater is on.
	Set temp. achieved	Shows that the water temperature has reached the target point and the unit shut off automatically.
SET	Parameter setting	Shows that the parameter is adjustable.
TEMP	Temperature	Shows that the temperature is non-adjustable (measured value).
	Timer & ON	Shows that the unit will be turned on by the timer automatically.
	Timer & OFF	Shows that the unit will be turned off by the timer automatically.
min	Minute	Shows that the main display area displays the minute.
S	Second	Shows that the main display area displays the second.
°C	Centigrade	Shows that the temperature in Main display area or Auxiliary display area is in C
°F	Fahrenheit	Shows that the temperature in Main display area or Auxiliary display area is in F
	Lock	Shows that the keyboard is locked.



Important – If the iStore display does not detect activity for 60 seconds the screen will enter sleep mode which requires a simple tap on the button to reactivate it. After a further 3 minutes of inactivity the screen will lock to prevent unwanted changes. To unlock the screen simply press and hold the power button for 8 seconds.

Functionality

Turn ON/OFF the unit

Press , hold for 2 seconds and release, the unit will turn on and the LED will display the internal water temperatures.

Press , hold for 2 seconds and release, the unit will turn off and the LED will display the OFF status.

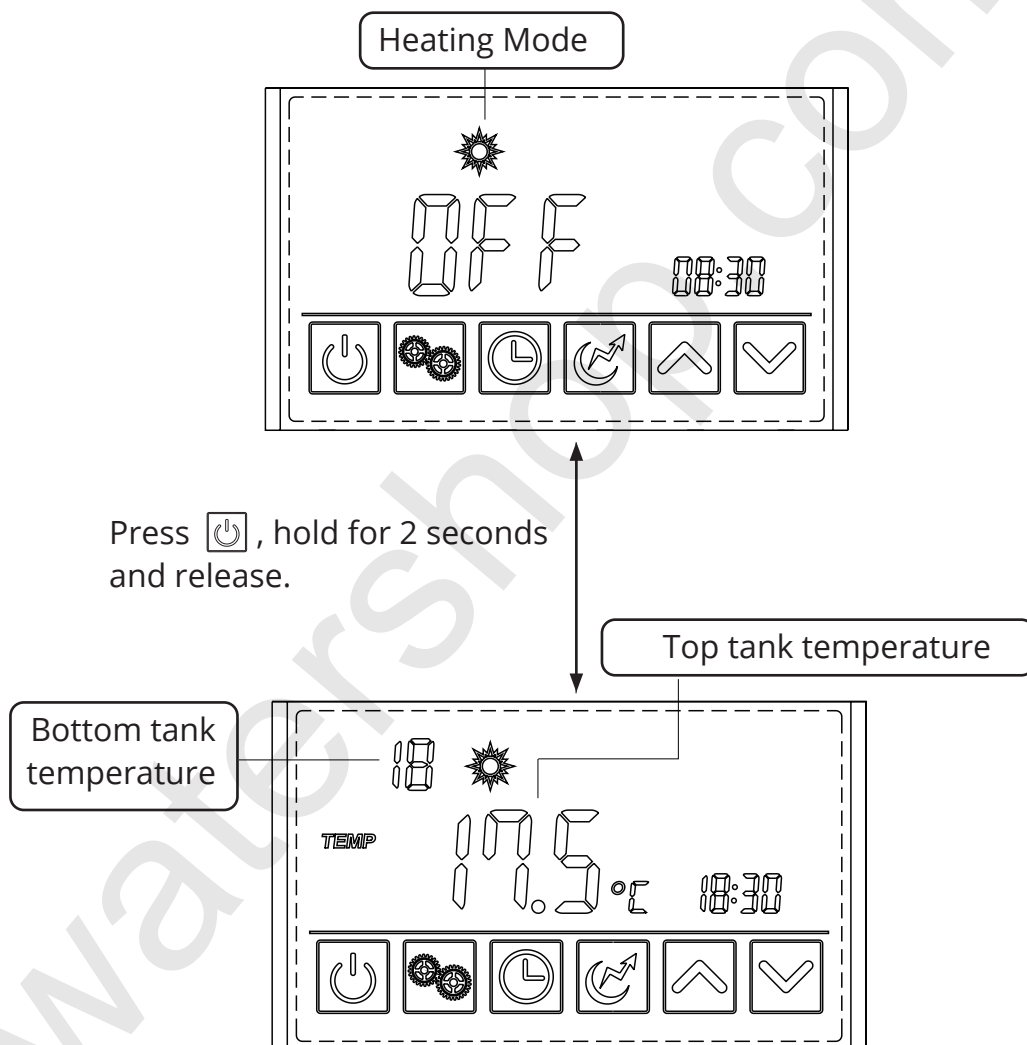

Functionality

Mode selection

Press “” to select the modes including Hybrid Heating, Eco Mode, Intelligent and Vacation in the standby or running interface.

! The Federal Government Clean Energy Regulator specifies how the iStore compressor hot water systems must operate in Australia and as such how the computer control operates. Intelligent and Hybrid modes are for overseas models and effectively overridden to Economic (ECO) mode in Australia.

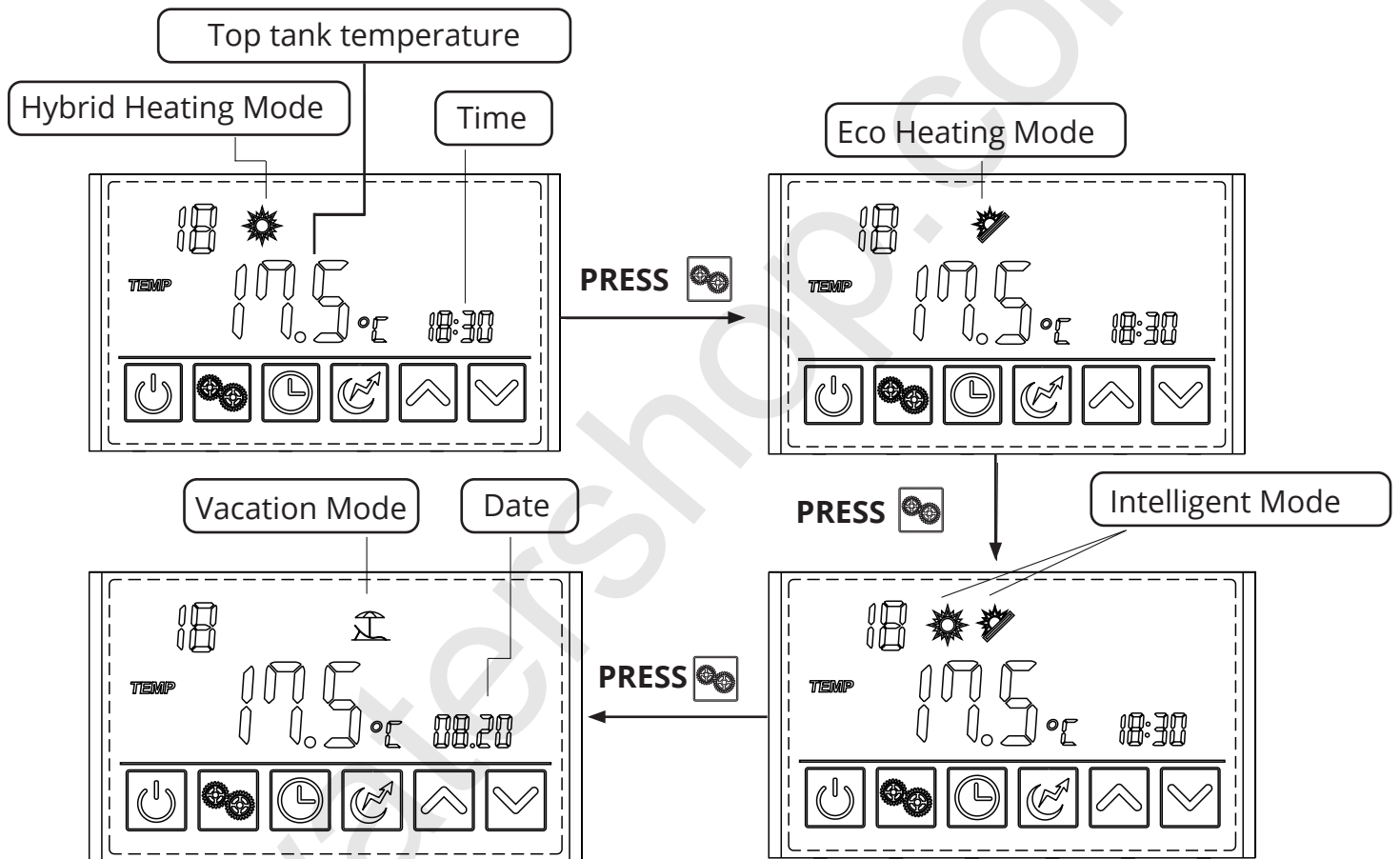

Functionality

Target temperature checking and settings

In the standby or running interface, press "☑" or "☒" once to check the target temperature of the outlet water. Press "☑" or "☒" again to change the target temperature. After making the changes to the parameter, press "⏻" to confirm or "⏻" to cancel the changes, then return to the previous interface. If no operations are performed on the keypad for 5s, the controller exits the parameter modification menu by timeout and the changes are confirmed.

Example: Change the target temperature from 50° to 60° when the actual top tank temperature is 17.5°.

iStore strongly recommends that 60°C is the default setting for optimal hot water delivery.

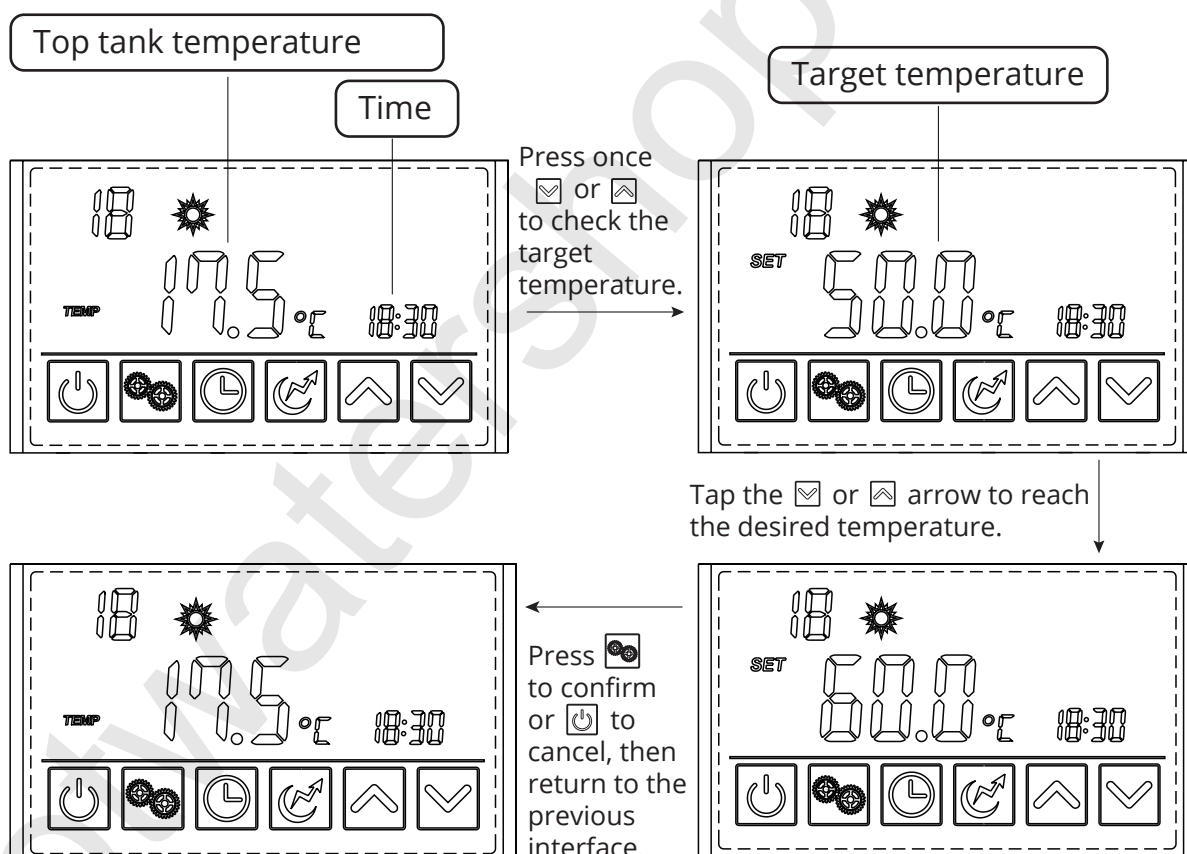

Functionality

Setting the Time Example: Change the time and date from 18:30 on August 4th to 17:40 on September 8th.

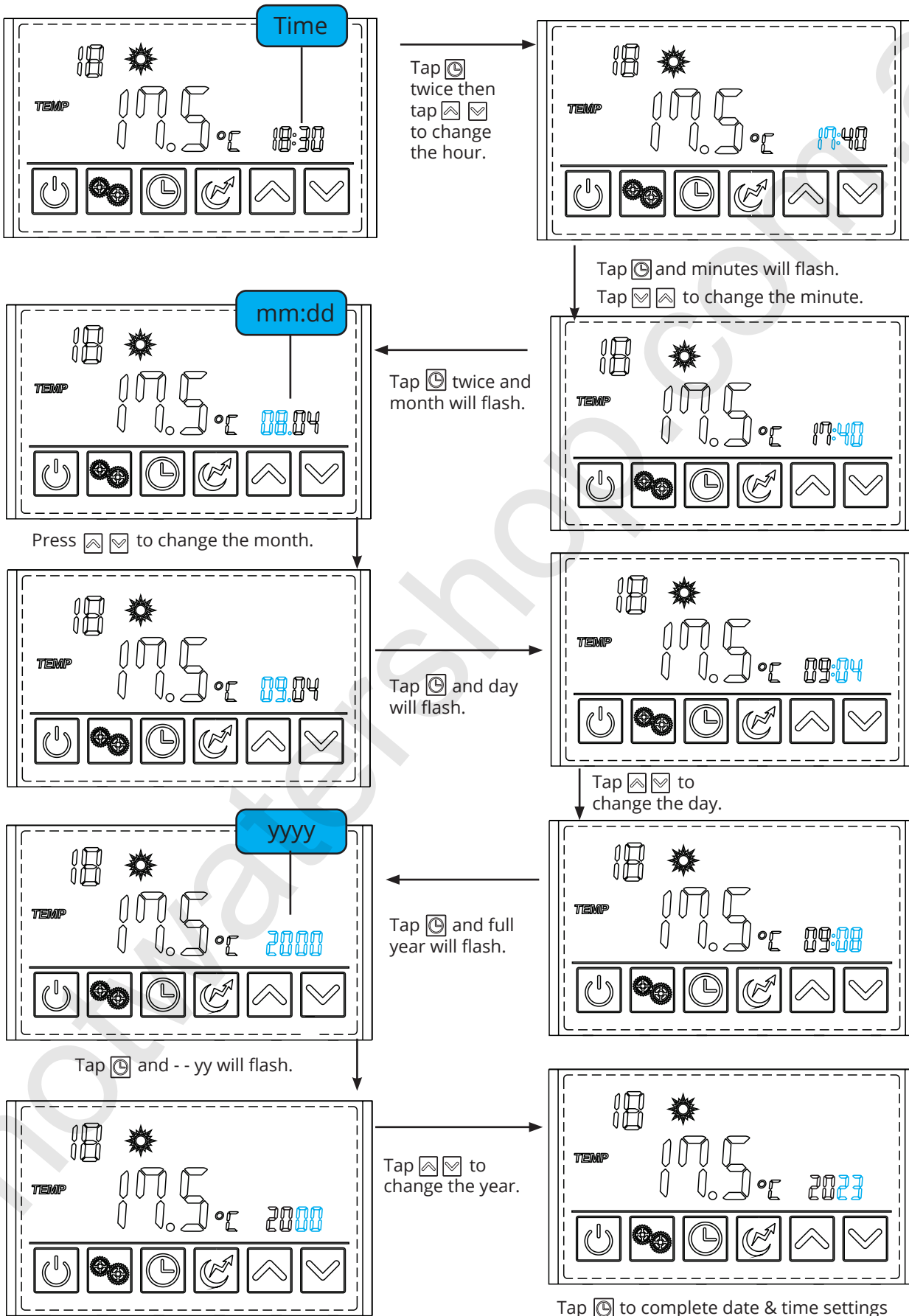

Functionality

Timer setting (All modes except Vacation mode)

! NOTE: A timer is not mandatory for the iStore operation. Factors such as household demand, time of use, individual supplier peak and offpeak electricity rates, solar panel Feed In Tarrif rates all may influence what heating schedule best suits a household.

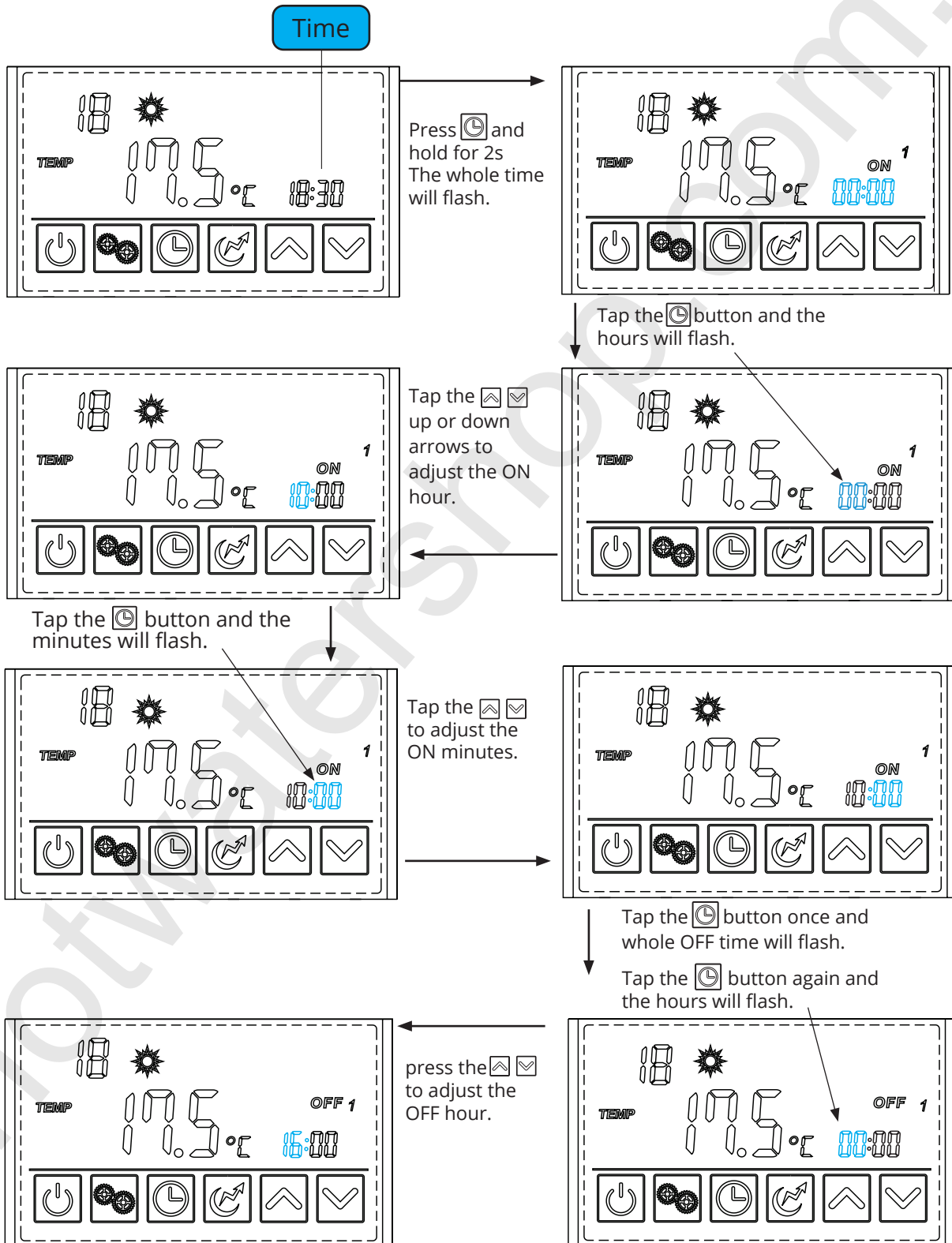

see next page

Functionality

continued

Tap the  button and the minutes will flash

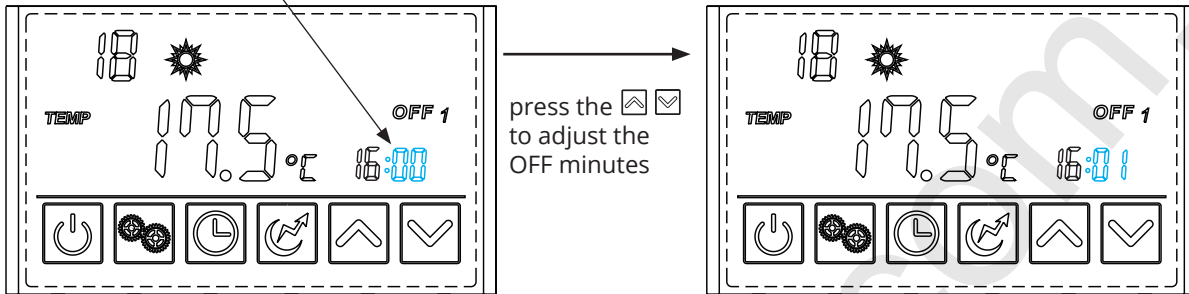

! NOTE: IF YOU ONLY REQUIRE 1 TIMER THEN YOU MAY LET THE TIMER FUNCTION TIMEOUT AND THE SECOND TIMER WILL REMAIN BLANK WITH "--:--" VALUES.

If you require a second timer then tap the clock button again and step through setting the ON 2 and Off 2 times in the same manner as described above.

! **Important Information**

For units manufactured from January 2023 ignores timers with the same start and end time, that is 00:00 on through 00:00 off will not activate as 12:00 on thru 12:00 off will also not activate.

On and off times should have differing minutes also to ensure the desired period is achieved.

For example for a full daytime timer a start of 10:00 on thru 16:00 should have the minute increased to 16:01 to confirm the timer window operation.

For units manufactured prior to January 2023 do not set the second timer to 00:00 ON and 00:00 OFF as the unit will commence heating at midnight every second night.

Functionality

Timer setting summary

All modes except Vacation mode.

Press and hold the  button 2 seconds, the "ON" and "1" will flash,

ON 1

tap the  and the hour value will flash, adjust the hour up or down with the   buttons

tap the  again and the minute value will flash, adjust the minute up or down with the   buttons

OFF 1

tap the  again and the full hh:mm will flash,

tap the  again and the hour value will flash, adjust the hour up or down with the   buttons

tap the  again and the minute value will flash, adjust the minute up or down with the   buttons

NOTE: IF A SECOND TIMERS IS NOT REQUIRED ALLOW THE LCD TO TIME OUT AT THIS POINT

ON 2

tap the  again and the full hh:mm will flash,



tap the  again and the hour value will flash, adjust the hour up or down with the   buttons

tap the  again and the minute value will flash, adjust the minute up or down with the   buttons

OFF 2

tap the  again and the full hh:mm will flash,

tap the  again and the hour value will flash, adjust the hour up or down with the   buttons

tap the  again and the minute value will flash, adjust the minute up or down with the   buttons

tap the  again and the LCD will return to ON 1, allow the LCD to time out at this point.

When the LCD returns to the default state the display will indicate whether 1 or 2 timers are set just above the digital clock, eg

1 timer **OFF1**
ON 2 timers **OFF1 2**
ON

Functionality



EXAMPLE ONLY: *Running period 1: 10:00 ~ 16:01; Running period 2: 00:00 ~ 03:01.*

To review the timers press and hold button, do not release, the LCD will display each of the four ON and OFF times in order. Release the button after review and let the LCD time out.

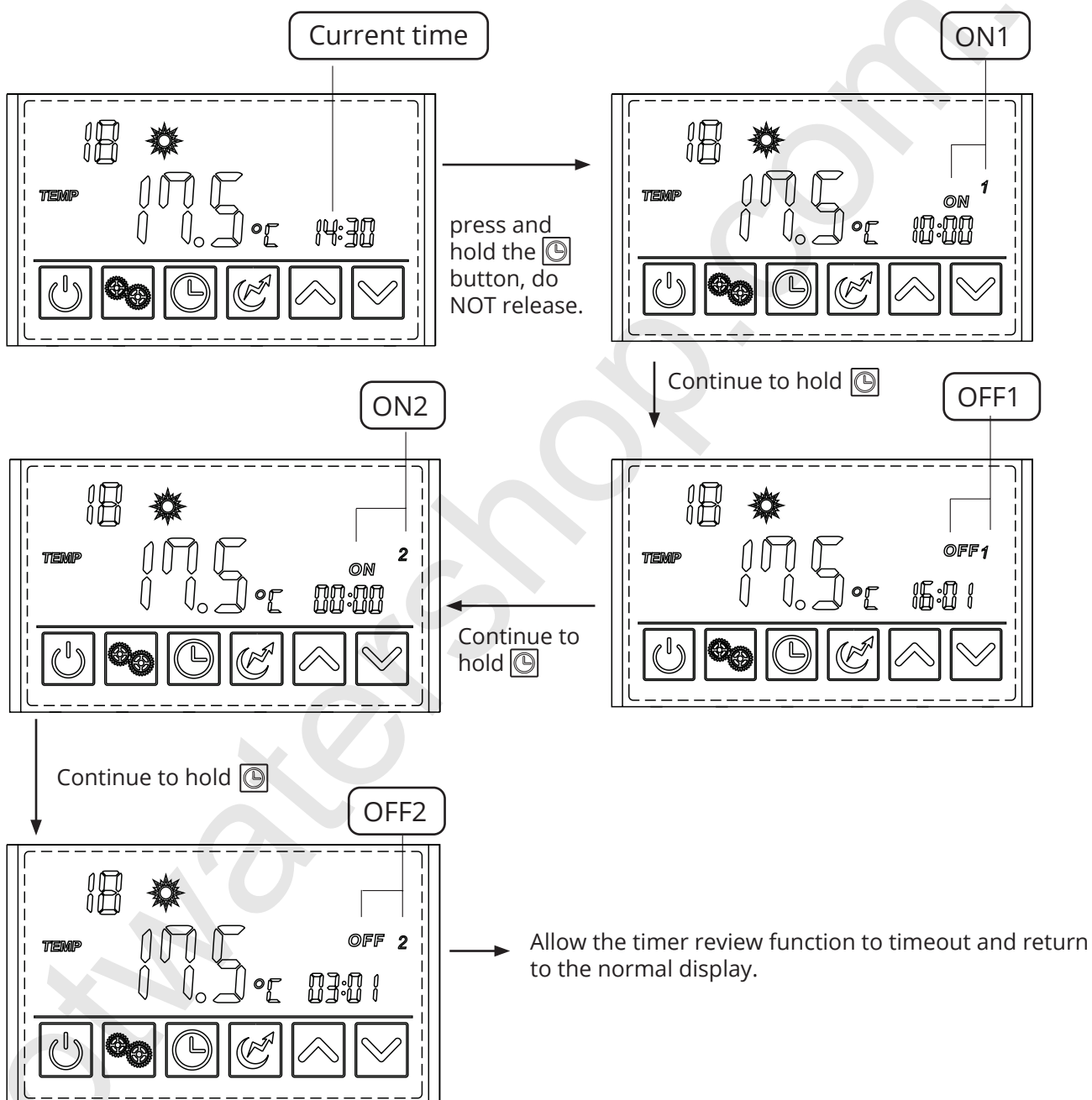

NOTE: Do not set the second timer to 00:00 ON and 00:00 OFF as the unit will commence heating at midnight every second night. To leave the second time off simply allow the timer setting to timeout after setting the first timer end time.

Functionality

Canceling the Timer Setting

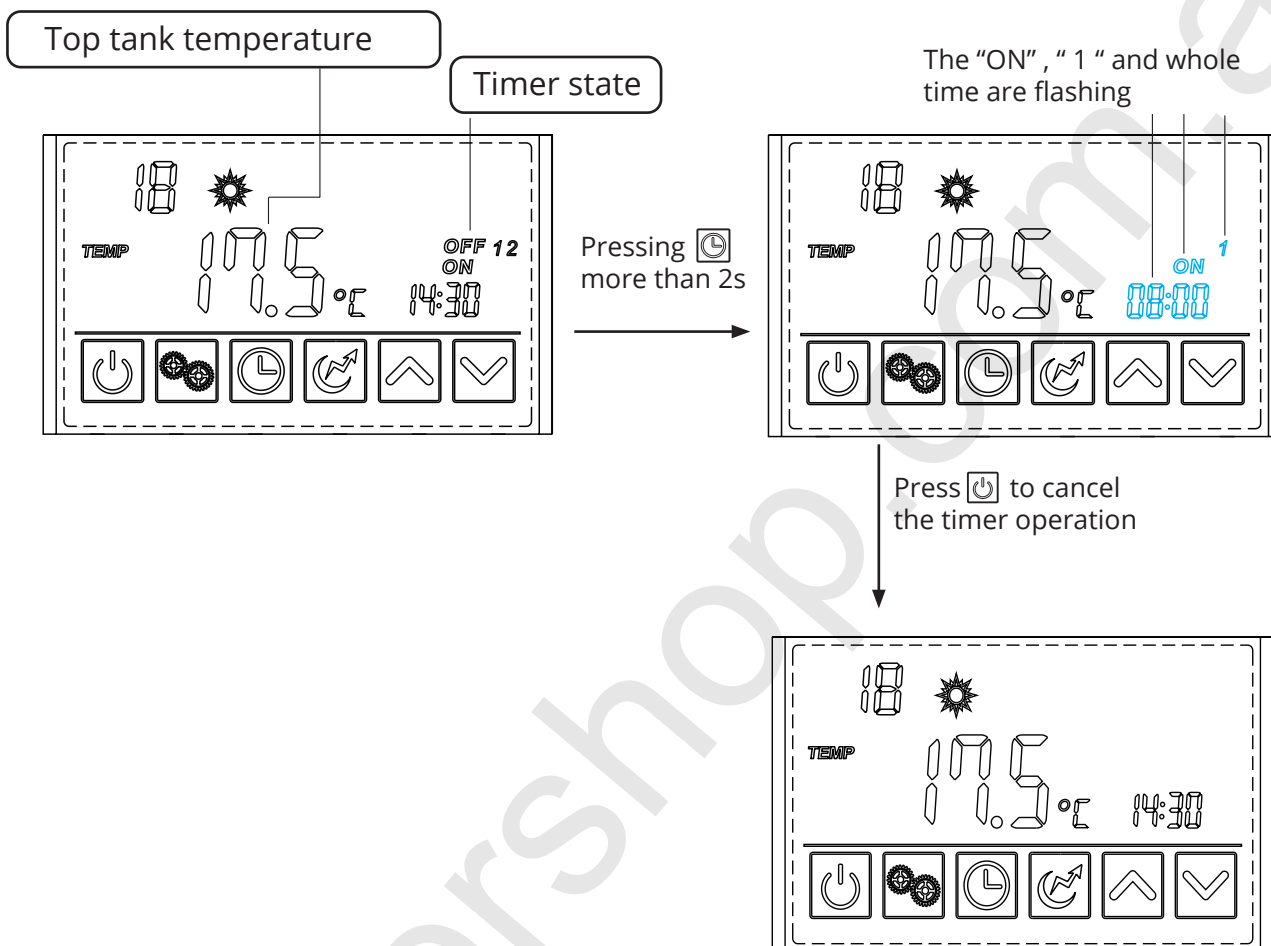

Functionality

Vacation Mode (Setting the date of your return from your vacation)

! IMPORTANT: To enter vacation mode firstly press the until the vacation icon is displayed. Press and hold the for 2 seconds then release to turn the unit OFF.

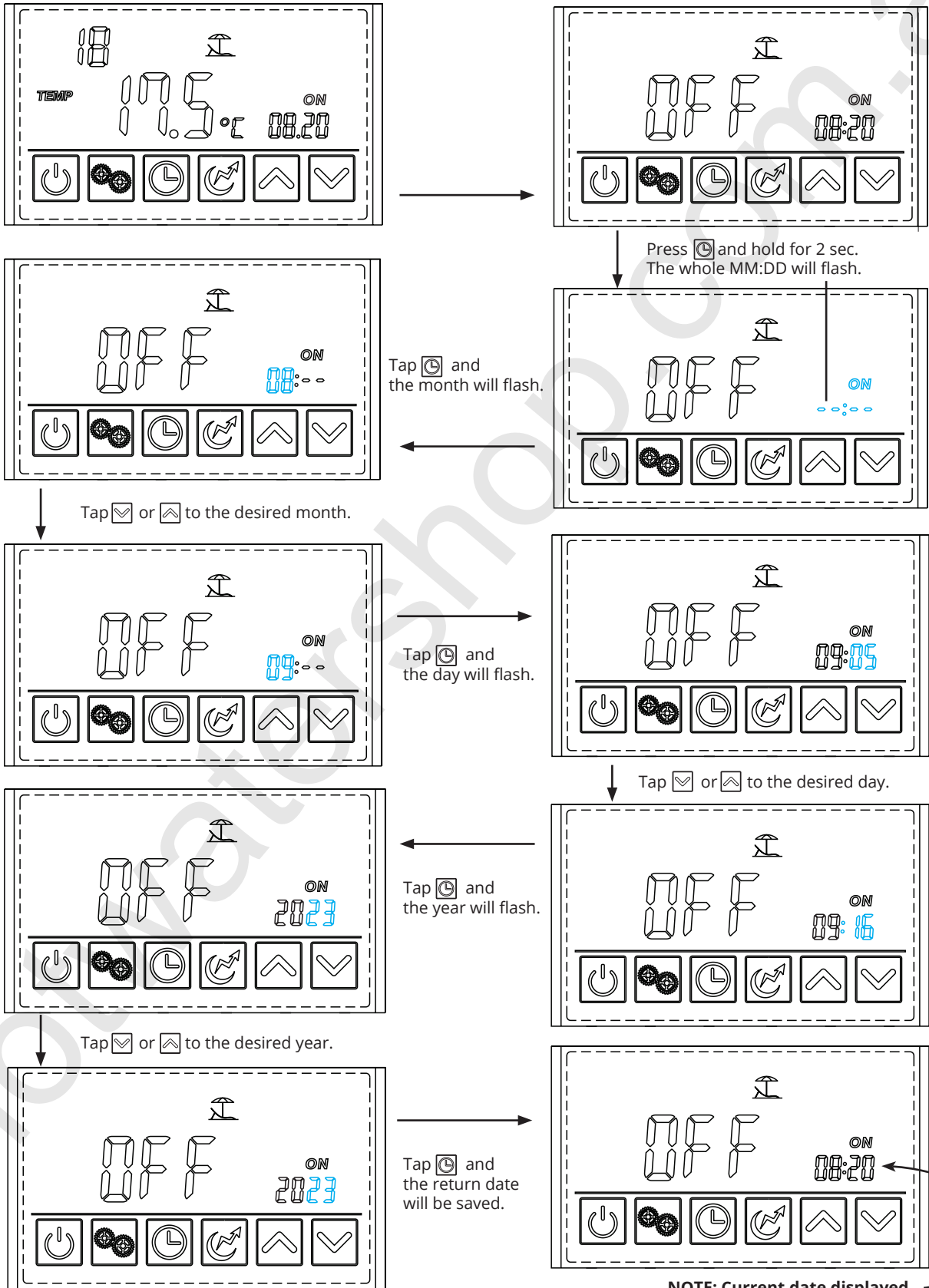

Functionality

Electric heater setting

The electric heater can be turned on when the unit is heating or standby.

Press "🔌" once to turn on the electric heater and press "🔌" again to shut it off.

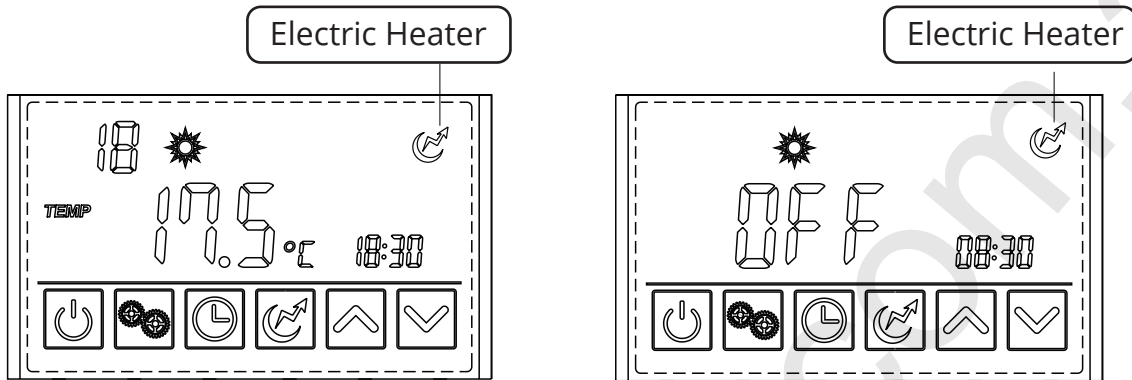

Home Owner Maintenance

Temperature and Pressure Relief valve PTV/PTR (all tanks)

The iStore hot water system is fitted with an 850kPa PTR Valve, which is located on the side of the cylinder and is essential for its safe operation. It is important that you operate the easing knob or lift the lever on the PTR valve once every 6 months. **It is important you rotate the knob or lever gently so seat is not damaged.**

Expansion Control Valve (ECV) (if applicable)

In some states and local councils, the installation of an Expansion Control Valve (commonly referred to a cold-water expansion valve) is required to be installed. If this valve is fitted, follow the same procedure for PTR valve as explained above.

Condensation line

Regularly inspect the condensation line to ensure water is dripping freely for the line. If the condensate drain is blocked at the discharge end, clear any debris that may have collected in the line. During normal operation, condensation occurs from the transfer of air across the evaporator coil. This process is drawing humidity from the air and creates condensation/ water droplets on the coils, which in turn is captured in the fully moulded condensate tray and discharged through the condensate drain line. In locations with humidity greater than 80%, up to 5 litres per day can be expected under normal operating conditions.

Obstructions

Regularly check the no obstructions are interfering with the air in-take or air discharge. If unit is installed near shrubs or trees, keep them trimmed so they do not interfere with air flow.

Insulation

Your installation by a licensed plumber should've included UV stable insulation. Periodically inspect the insulation to ensure that no deterioration or damage by external influence has occurred.

Note: Up to 60% heat loss can occur if the insulation is non-existent or substandard. Therefore, please pay particular attention to making sure the system is properly insulated and any external insulation is UV Protected.

iStore hot water tank – 5 year service – Authorised/licensed plumber

The five-yearly service should be carried out by a licensed tradesperson. It is recommended that this service be carried out by your local iStore agent. The service should include the following:

1. Replace the pressure & temperature relief valve.
2. Replace the anode (anodes should be replaced more frequently if subjected to hard water conditions, refer table in the warranty exclusions, iStore must be consulted regarding the replacement anode if not a genuine iStore anode). If the TDS is greater than 600PPM, the anode shall be inspected every year and replaced at intervals not greater than every 2 yrs.
3. Flush the water heater.
4. Replace tempering valve if specified by valve manufacturer.

Trouble Shooting

PROBLEM	SOURCE	EXPLANATION
Water not as hot as previous hot water system	Tempering Valve installed	A tempering valve must be installed on every solar hot water system. Tempering valves will mix water down to 50°C.
No Power at Screen	Circuit breaker turned off AC Isolator Turned Off Power surge	Check Circuit breaker in meter box. Check AC Isolator in on position. Contact iStore.
No Hot Water - 1	Faulty Tempering Valve	Pull PTR lever and check if water is hot. If water is hot, contact a licensed plumber to replace tempering valve.
No Hot Water - 2	Off-Peak Tariff	Check screen to see if power is available during your nominated off-peak tariff heating times. Refer to your electricity distributor should power not be available from off-peak supply.
No Hot Water - 3	Timer not set correctly	Ensure that timer is set to heat to your hot water demands. A secondary heating cycle maybe required if large hot water demand is used twice per day. Refer above instructions for timer settings.
Luke Warm Hot Water - 1	Tempering Valve	Tempering valve not mixing water correctly. Contact a licensed plumber to inspect / replace the valve.
Luke Warm Hot Water - 2	Excessive Hot Water load	Unexpected additional hot water load. Plan hot water usage to be staggered, not continuous consumption. Wait for system to re-heat. Increase timer setting if in use. Utilise Hybrid Mode to decrease re-heating time.
Overflow pipe is dripping	Pressure Temperature Relief Valve (PTR) / Expansion Control Valve (ECV) where applicable.	An 850kPa and 99°C PTR valve is used on the iStore water tank, which is located on the side of the water tank and is essential for its safe operation. The PTR valve is designed to allow 3-5% of total tank volume to discharge during heating to allow for hot water expansion.
Water pressure is slightly lower than previous hot water system	Pressure Reduction Valve (PRV)	A pressure reduction valve has been installed to limit the inlet pressure to your new iStore Water Heater. This device regulates the incoming pressure & increases life of the cylinder. This device will also protect your cylinder if the mains pressure is increased by the local water authority.

Terms and Conditions of warranty

1. For all warranty issues please contact iStore on 1300 515 636 or email info@istore.net.au.
2. This warranty is effective for all iStore hot water systems manufactured and installed after 1st October 2022.
3. If the customer has not paid in full for the iStore hot water system then this warranty does not apply.
4. iStore hot water system and its components are covered by a warranty against defective factory parts or workmanship from the date the iStore hot water system is installed for the relevant period for such component as outlined in Table 1 - warranty Periods. If the date of installation is unknown, the warranty commences one (1) Month after the date of manufacture.
5. This warranty is for normal domestic use of the iStore hot water system only.
6. To the extent a claim falls under the "Parts Only" warranty Period the warranty covers the replacement only of such failed component in the iStore hot water system free of charge. Subject to an area within a 30-kilometre radius of the iStore Branch or Authorised Distributor from where the unit was purchased. Customers outside this area will be subject to any freight costs and any travelling charges incurred by the iStore representative carrying out the rectification. "Parts Only" warranty period excludes labour.
7. To the extent a claim falls under the "Parts and Labour" warranty Period, the warranty covers the repair and/or replacement of such failed component in the iStore hot water system and any associated labour costs free of charge. Subject to an area within a 30-kilometre radius of the iStore Branch or Authorised Distributor from where the unit was purchased. Customers outside this area will be subject to any freight costs and any travelling charges incurred by the iStore representative carrying out the rectification.
8. The decision to repair or replace the component the subject of the warranty will be entirely at the discretion of iStore.
9. Where a iStore hot water system or a component thereto is repaired or replaced by iStore, the balance of any original warranty Period will remain effective. The repaired or replaced part does not carry any additional warranty period.
10. Upon installation of the iStore hot water system, it is the consumer's responsibility to register their warranty on-line www.istore.net.au/warranty-registration. Consumer must provide the following detail - home OWNER'S detail, product model number, product installation date, product serial numbers, licensed plumber contact details. Once you have successfully completed the on-line registration form, you will be notified of successful warranty registration. If you do not have access to the internet, please contact iStore on 1300 515 636 to register your warranty. To be eligible to make a claim under this warranty, consumer must register their warranty within 6 weeks of the installation.
11. The iStore hot water system must be installed in accordance with iStore's installation instructions, and all relevant local, state and national statutory requirements, including but not limited to, AS/NZS 35004 & 5, AS/NZ S5601, AS/NZS 3000 and AS/NZS 2712.

Terms and Conditions of warranty

12. Installation must be completed by licensed plumbers and electricians that are licensed in the State or Territory in which the installation is completed. Installation must include all relevant valves as required by federal/state regulations & shall incorporate a 500kPa Pressure Reduction Valve. Installation of a Pressure Limiting Valve does not comply with manufactures installation instructions. Failure to incorporate a 500kPa Pressure Reduction Valve will void this warranty.
13. The electrical system components must be installed in a domestic application and connected to a 240V power supply by a qualified electrician in accordance with AS/NZS 3000.
14. iStore reserves the right to alter the design, components or construction to its iStore hot water system. Such alterations shall not constitute a defect in design or construction under this warranty. See warranty Table on next page.
15. Any claim under this warranty must include full details of the defect and/or damage to the iStore System. All claims must be made within one (1) month of detection of the defect.
16. Dated proof of purchase is required prior to commencement of any work under this warranty. This warranty does not apply to any defects or damage NOT due to faulty factory parts or workmanship including, but not limited to, defects or damage caused by or resulting from: (a) accidental damage, storm damage, vandalism, failure due to misuse or abuse, or neglect of any kind; (b) incorrect or improper installation of the iStore hot water system, including but not limited to, installation otherwise than in accordance with the instructions contained in the installation manual supplied by iStore or incorrect system selection; (c) alteration or repair of the iStore hot water system other than by a licensed plumber/electrician/refrigeration mechanic or by an approved iStore agent; (d) attachment of any parts or accessories other than those manufactured or approved by iStore; (e) freezing in regions with minimum temperatures below -10°C; (f) the power supply to the iStore hot water system being cut; (g) power surges; (h) animals, birds and/or rodents; (i) excessive water pressure, negative pressure (partial vacuum), excessive temperature, corrosive atmosphere, faulty plumbing and/or electrical wiring; (j) sludge/sediment as a result of connection to a water supply from unfiltered or treated sources i.e. spring, dam, bore, river or town supply from a bore; (k) contamination and corrosion from particles in the water supply; (l) serial tags/stickers on any of the components being removed or defaced; (m) the iStore hot water system being relocated from its original point of installation; (n) the water stored in the cylinder exceeding at any time the following levels: (o) If penetrations are made through the tank skin by the installer, warranty will be void immediately; (p) Damage caused by transport; (q) if the system has been re-installed at a location other than the original location.

Total hardness	200 mg/litre or p.p.m
Total dissolved solids	600 mg/litre or p.p.m
Electrical conductivity	850 μ S/cm
Chloride	250 mg/litre or p.p.m
Magnesium	10 mg/litre or p.p.m
Sodium	150 mg/litre or p.p.m
pH	Min 6.5 to Max 8.5

Terms and Conditions of warranty

17. iStore does not warrant any work conducted by a third-party installer of the iStore hot water system.
18. This warranty only applies to the iStore hot water system and its components and does not cover any plumbing or electrical associated parts, including but not limited to any parts supplied by any person installing the iStore hot water system.
19. To the extent permitted by law, iStore shall not be liable under this warranty for any consequential loss or damage or any incidental expenses resulting from any breach of this warranty, including but not limited to, claims for damage to buildings, roofs, ceilings, walls, foundations, gardens, personal belonging or household effects, fixtures and fittings. Or any other consequential loss, damage or inconvenience, either directly or indirectly due to leakage from the iStore hot water system or any other matter related to the system or its operation.
20. The benefits conferred by this warranty are in addition to all other rights and remedies in respect of the iStore hot water system, which the purchaser has under the Competition and Consumer Act 2010 and consumer protection legislation of the States and Territories. Nothing in this warranty has the effect of excluding, restricting or modifying those rights.
21. Goods presented for repair may be replaced by refurbished goods of same type rather than being repaired. Refurbished parts may be used to repair/replace the goods.
22. Our goods come with guarantees that cannot be excluded under the Australian Consumer Law. You are entitled to a replacement or refund for a major failure and compensation for any other reasonably foreseeable loss or damage. You are also entitled to have the goods repaired or replaced if the goods fail to be of acceptable quality and the failure does not amount to a major failure.
23. iStore strongly recommends that the consumer update their household insurance policy.

Component warranty Table

This warranty is effective for all iStore hot water systems manufactured and installed after 1st October 2022.

COMPONENT	warranty PERIOD (Parts Only)	warranty PERIOD (Parts and Labour)
iStore Glass Lined Tank	5 years	5 year
Refrigeration	5 years	5 years
Electrical (controller and sensor leads)	5 years	5 years
Sacrificial Anode & PTR valve	1 year	1 year
Consumable Items	1 year	1 year

Specifications

2.1 Dimensions 270L

Unit: mm

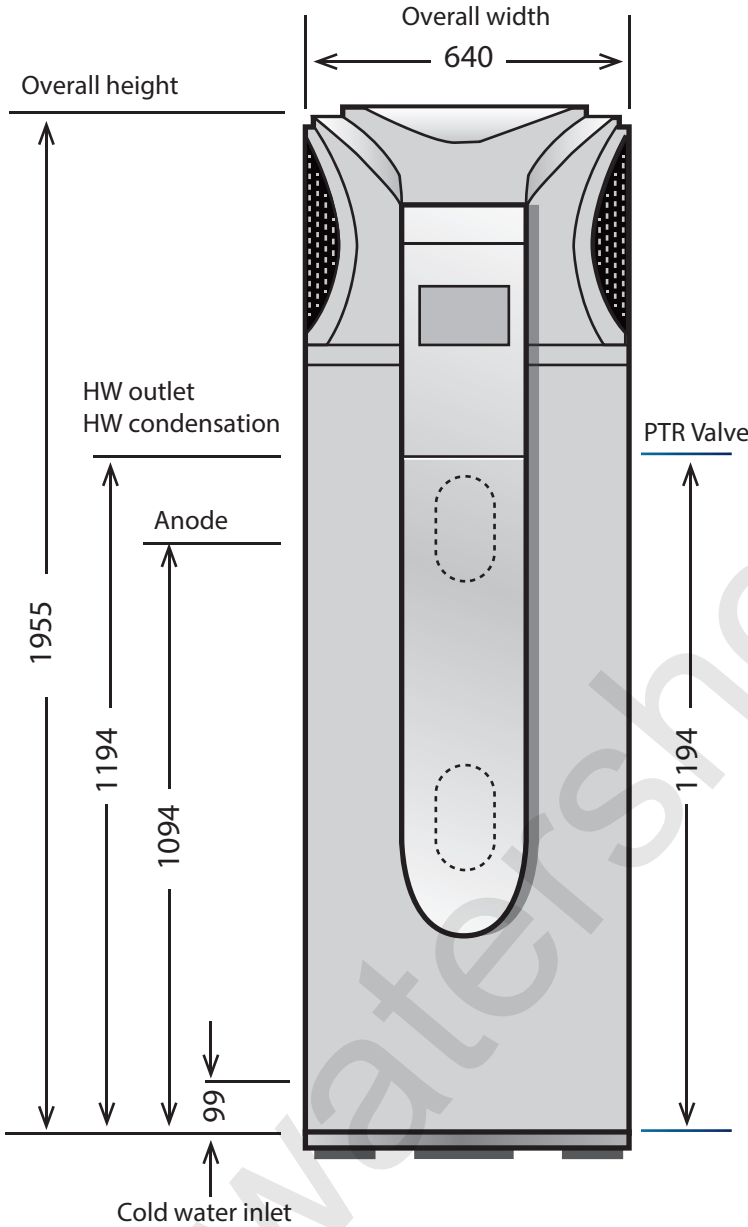

Dimensions	
Height (mm)	1955
Diameter (mm)	640
Height to water inlet (mm)	99
Height to water outlet (mm)	1194
Hot water condensation (mm)	
Height to PTR Valve (mm)	
Height to Anode	1094
Net weight (Kg)	130

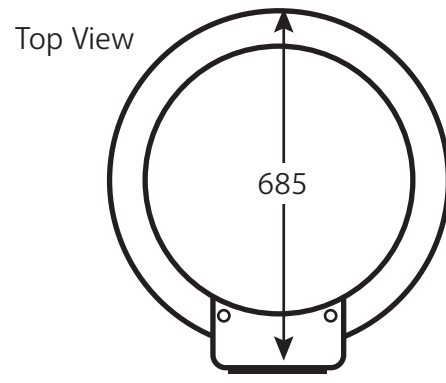

270L iStore

Specifications

2.2 Dimensions 180L

Unit: mm

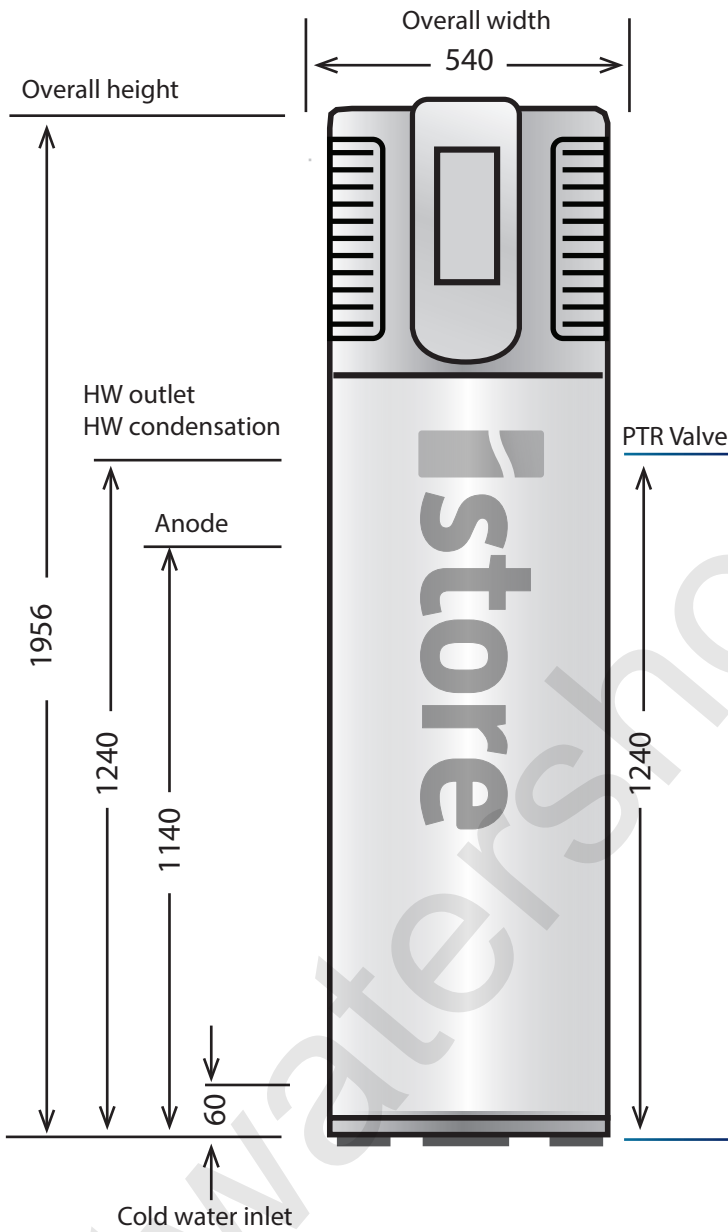

Dimensions	
Height (mm)	1957
Diameter (mm)	540
Height to water inlet (mm)	60
Height to water outlet (mm)	1240
Hot water condensation (mm)	
Height to PTR Valve (mm)	1140
Height to Anode	
Net weight (Kg)	93

Top View

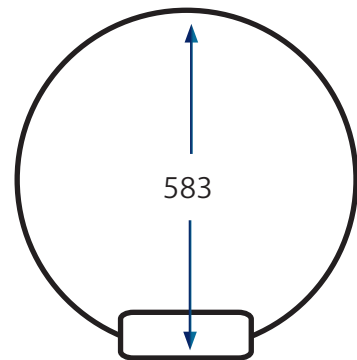

180L iStore

NOTES

hotwatershop.com.au

After Sales Service Guaranteed

Thank you for joining iStore in our mission to lead the way to a sustainable energy future.

Supplier Name: _____ Installation Date: _____

Supplier Address: _____ Supplier Phone: _____

System Model / Type: _____

